

Rivenditore : Atmosfera _____

Località : Ponteranica _____

Marca : Giellesse _____

Modello : Levante _____

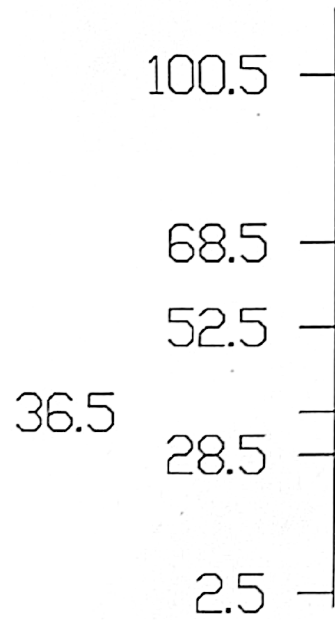

PIED.H.2.5

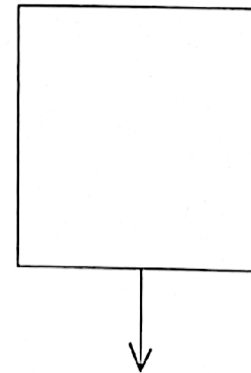
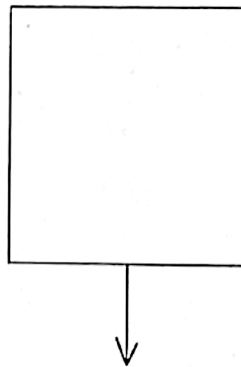
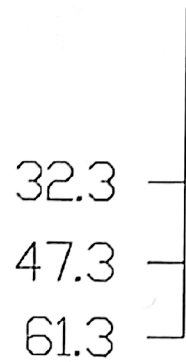
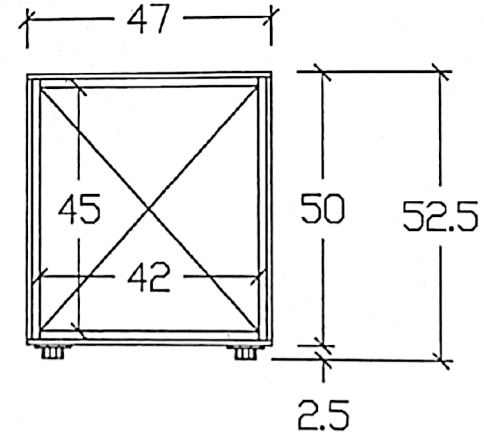
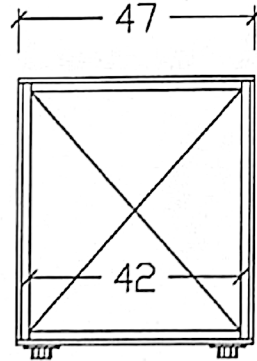

Rivenditore : Atmosfera _____
 Località : Ponteranica _____
 Marca : Giellesse _____
 Modello : Levante _____

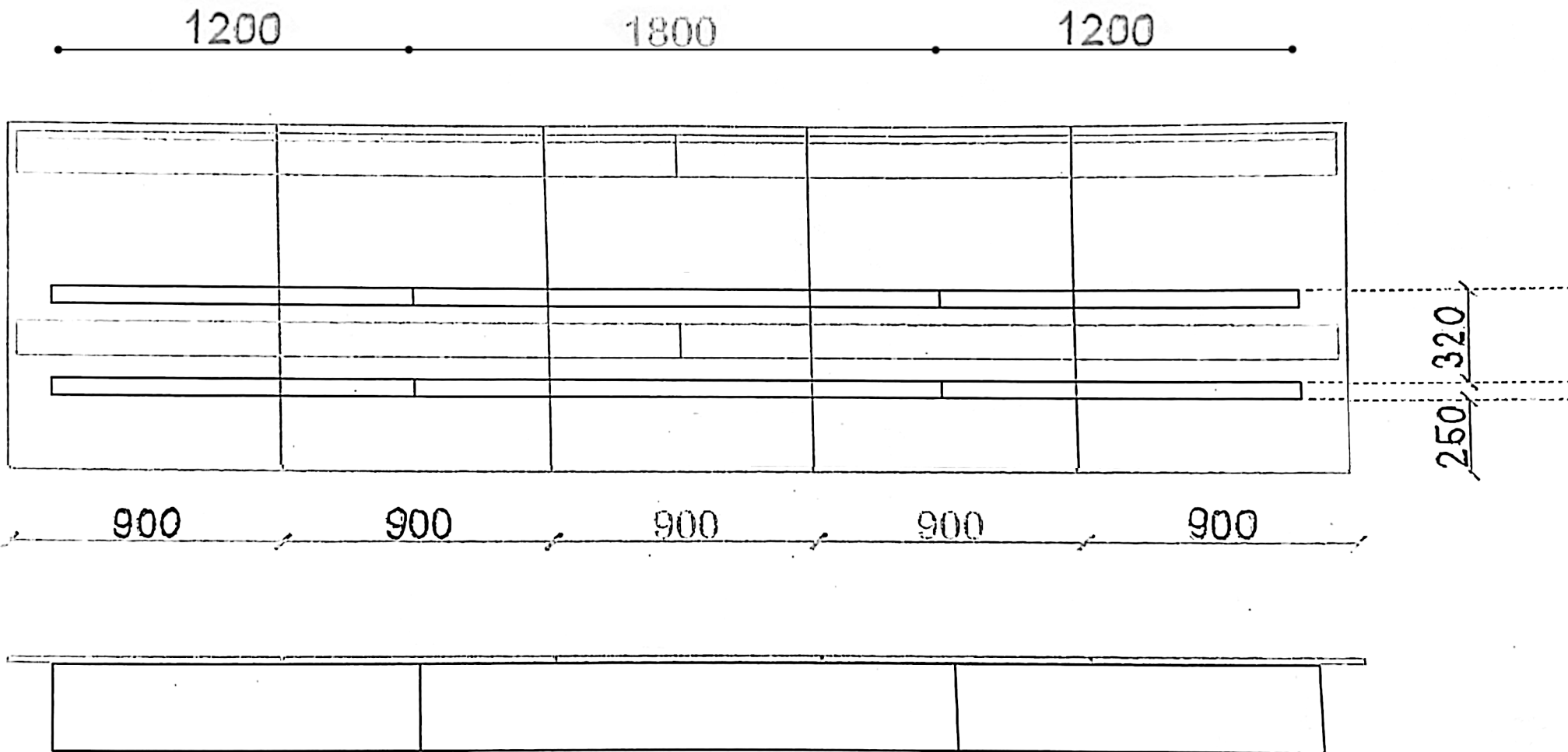

Rivenditore : Atmosfera

Località : Ponteranica

Marca : Giellesse

Modello : Levante